

INSULATED GATE BIPOLAR TRANSISTOR

Short Circuit Rated
UltraFast IGBT

Features

- Short circuit rated - 10 μ s @ 125°C, V_{GE} = 15V
- Switching-loss rating includes all "tail" losses
- Optimized for high operating frequency (over 5kHz) See Fig. 1 for Current vs. Frequency curve

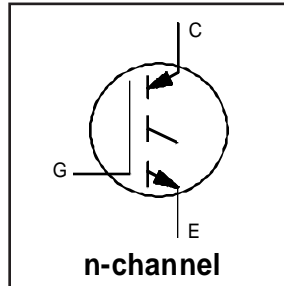

V _{CES} = 600V
V _{CE(sat)} ≤ 3.5V
@V _{GE} = 15V, I _C = 6.0A

Description

Insulated Gate Bipolar Transistors (IGBTs) from International Rectifier have higher usable current densities than comparable bipolar transistors, while at the same time having simpler gate-drive requirements of the familiar power MOSFET. They provide substantial benefits to a host of high-voltage, high-current applications.

These new short circuit rated devices are especially suited for motor control and other applications requiring short circuit withstand capability.

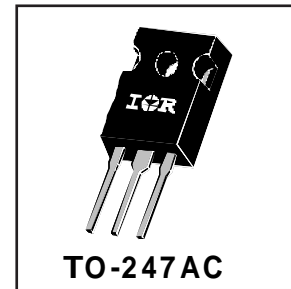

Absolute Maximum Ratings

	Parameter	Max.	Units
V _{CES}	Collector-to-Emitter Voltage	600	V
I _C @ T _C = 25°C	Continuous Collector Current	10	A
I _C @ T _C = 100°C	Continuous Collector Current	6.0	
I _{CM}	Pulsed Collector Current ①	20	
I _{LM}	Clamped Inductive Load Current ②	20	
t _{sc}	Short Circuit Withstand Time	10	μs
V _{GE}	Gate-to-Emitter Voltage	±20	V
E _{ARV}	Reverse Voltage Avalanche Energy ③	5.0	mJ
P _D @ T _C = 25°C	Maximum Power Dissipation	60	W
P _D @ T _C = 100°C	Maximum Power Dissipation	24	
T _J	Operating Junction and Storage Temperature Range	-55 to +150	°C
T _{STG}			
	Mounting torque, 6-32 or M3 screw.	10 lbf•in (1.1N•m)	

Thermal Resistance

	Parameter	Min.	Typ.	Max.	Units
R _{θJC}	Junction-to-Case	—	—	2.1	°C/W
R _{θCS}	Case-to-Sink, flat, greased surface	—	0.24	—	
R _{θJA}	Junction-to-Ambient, typical socket mount	—	—	40	
Wt	Weight	—	6 (0.21)	—	g (oz)

Electrical Characteristics @ $T_J = 25^\circ\text{C}$ (unless otherwise specified)

	Parameter	Min.	Typ.	Max.	Units	Conditions
$V_{(BR)CES}$	Collector-to-Emitter Breakdown Voltage	600	—	—	V	$V_{GE} = 0V, I_C = 250\mu A$
$V_{(BR)ECS}$	Emitter-to-Collector Breakdown Voltage ②	20	—	—	V	$V_{GE} = 0V, I_C = 1.0A$
$\Delta V_{(BR)CES}/\Delta T_J$	Temperature Coeff. of Breakdown Voltage	—	0.37	—	V/°C	$V_{GE} = 0V, I_C = 1.0mA$
$V_{CE(on)}$	Collector-to-Emitter Saturation Voltage	—	2.4	3.5	V	$I_C = 6.0A, V_{GE} = 15V$
		—	3.6	—		$I_C = 10A$
		—	2.9	—		$I_C = 6.0A, T_J = 150^\circ\text{C}$
$V_{GE(th)}$	Gate Threshold Voltage	3.0	—	5.5		$V_{CE} = V_{GE}, I_C = 250\mu A$
$\Delta V_{GE(th)}/\Delta T_J$	Temperature Coeff. of Threshold Voltage	—	-11	—	mV/°C	$V_{CE} = V_{GE}, I_C = 250\mu A$
g_{fe}	Forward Transconductance ⑤	1.9	3.3	—	S	$V_{CE} = 100V, I_C = 6.0A$
I_{CES}	Zero Gate Voltage Collector Current	—	—	250	μA	$V_{GE} = 0V, V_{CE} = 600V$
		—	—	1000		$V_{GE} = 0V, V_{CE} = 600V, T_J = 150^\circ\text{C}$
I_{GES}	Gate-to-Emitter Leakage Current	—	—	± 100	nA	$V_{GE} = \pm 20V$

Switching Characteristics @ $T_J = 25^\circ\text{C}$ (unless otherwise specified)

	Parameter	Min.	Typ.	Max.	Units	Conditions
Q_g	Total Gate Charge (turn-on)	—	17	26	nC	$I_C = 6.0A$
Q_{ge}	Gate - Emitter Charge (turn-on)	—	4.3	6.8		$V_{CC} = 400V$
Q_{gc}	Gate - Collector Charge (turn-on)	—	6.4	11		$V_{GE} = 15V$
$t_{d(on)}$	Turn-On Delay Time	—	29	—	ns	$T_J = 25^\circ\text{C}$
t_r	Rise Time	—	18	—		$I_C = 6.0A, V_{CC} = 480V$
$t_{d(off)}$	Turn-Off Delay Time	—	58	90		$V_{GE} = 15V, R_G = 50\Omega$
t_f	Fall Time	—	120	200		Energy losses include "tail"
E_{on}	Turn-On Switching Loss	—	0.11	—	mJ	See Fig. 9, 10, 11, 14
E_{off}	Turn-Off Switching Loss	—	0.13	—		
E_{ts}	Total Switching Loss	—	0.24	0.31		
t_{sc}	Short Circuit Withstand Time	10	—	—	μs	$V_{CC} = 400V, T_J = 125^\circ\text{C}$ $V_{GE} = 15V, R_G = 50\Omega, V_{CPK} < 500V$
$t_{d(on)}$	Turn-On Delay Time	—	28	—	ns	$T_J = 150^\circ\text{C}$
t_r	Rise Time	—	22	—		$I_C = 6.0A, V_{CC} = 480V$
$t_{d(off)}$	Turn-Off Delay Time	—	200	—		$V_{GE} = 15V, R_G = 50\Omega$
t_f	Fall Time	—	145	—		Energy losses include "tail"
E_{ts}	Total Switching Loss	—	0.50	—	mJ	See Fig. 10, 14
L_E	Internal Emitter Inductance	—	13	—	nH	Measured 5mm from package
C_{ies}	Input Capacitance	—	360	—	pF	$V_{GE} = 0V$
C_{oes}	Output Capacitance	—	45	—		$V_{CC} = 30V$
C_{res}	Reverse Transfer Capacitance	—	4.7	—		$f = 1.0MHz$

Notes:

- ① Repetitive rating; $V_{GE}=20V$, pulse width limited by max. junction temperature. (See fig. 13b)
- ② $V_{CC}=80\%(V_{CES}), V_{GE}=20V, L=10\mu H, R_G=50\Omega$, (See fig. 13a)
- ③ Repetitive rating; pulse width limited by maximum junction temperature.
- ④ Pulse width $\leq 80\mu s$; duty factor $\leq 0.1\%$.
- ⑤ Pulse width 5.0 μs , single shot.

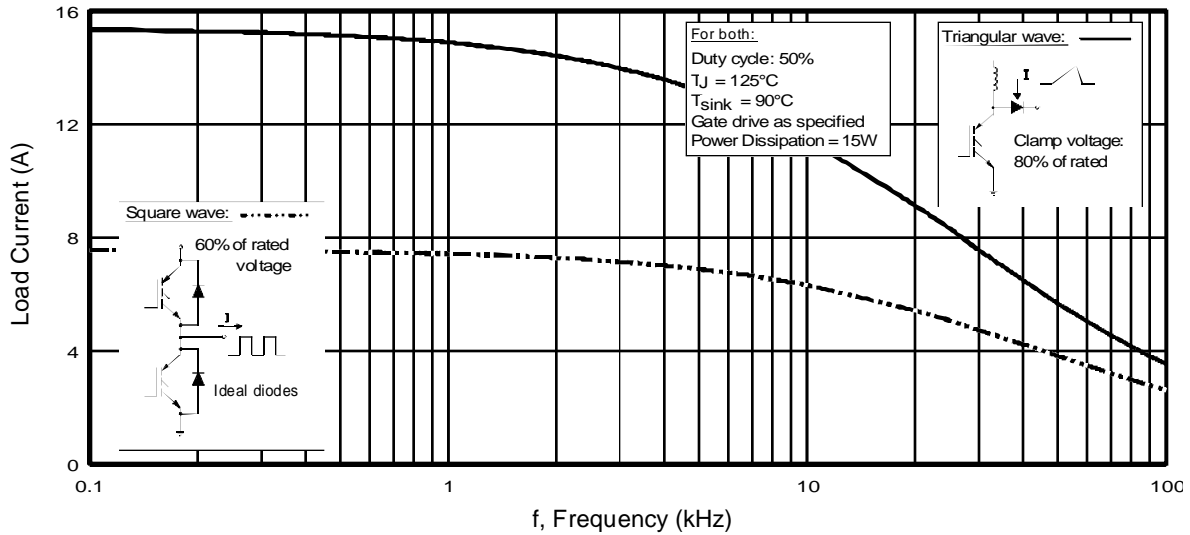

Fig. 1 - Typical Load Current vs. Frequency
 (For square wave, $I = I_{RMS}$ of fundamental; for triangular wave, $I = I_{PK}$)

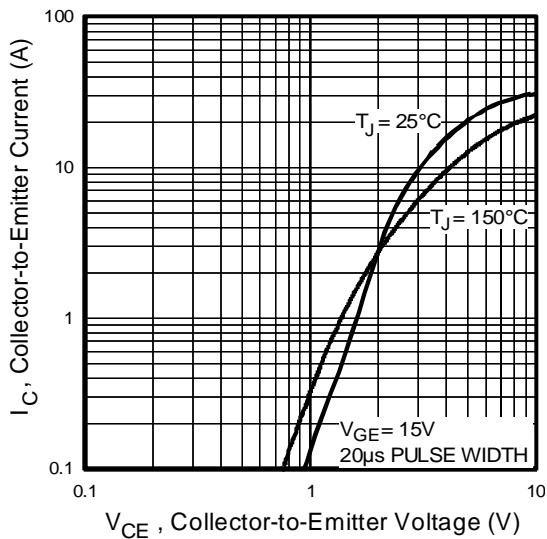

Fig. 2 - Typical Output Characteristics

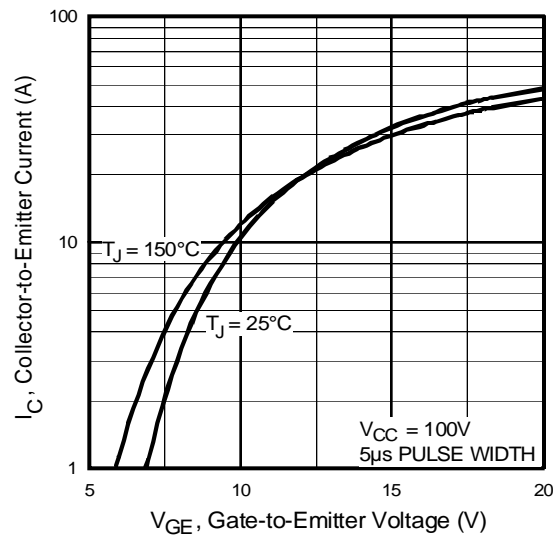

Fig. 3 - Typical Transfer Characteristics

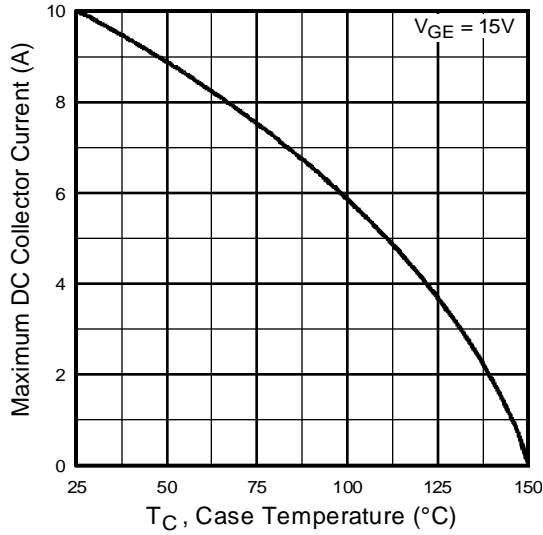

Fig. 4 - Maximum Collector Current vs. Case Temperature

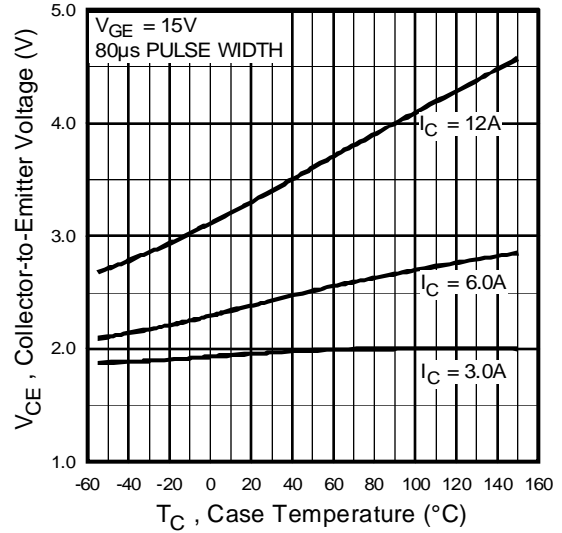

Fig. 5 - Collector-to-Emitter Voltage vs. Case Temperature

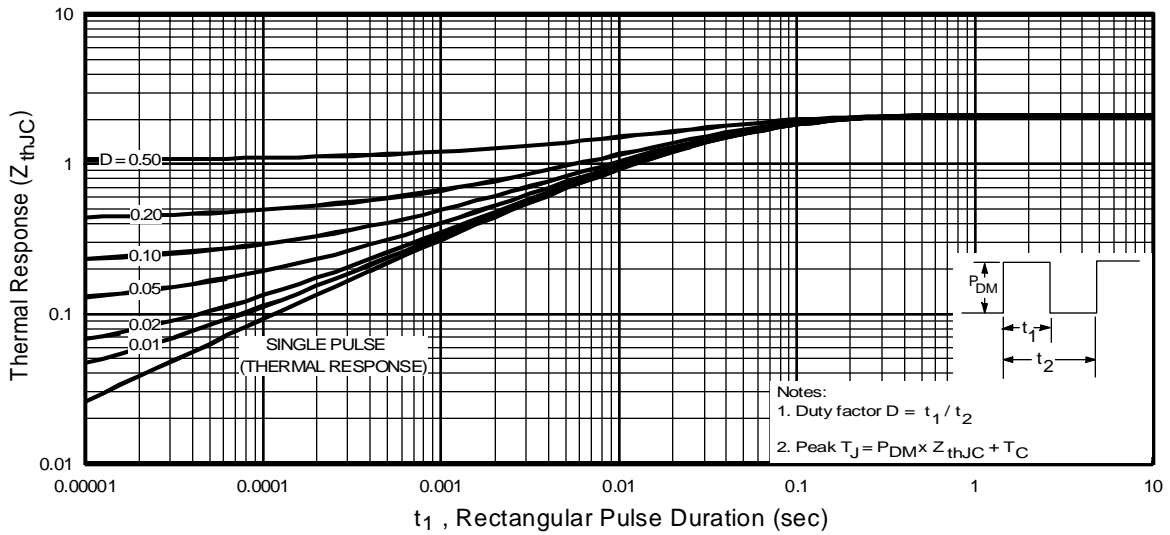

Fig. 6 - Maximum Effective Transient Thermal Impedance, Junction-to-Case

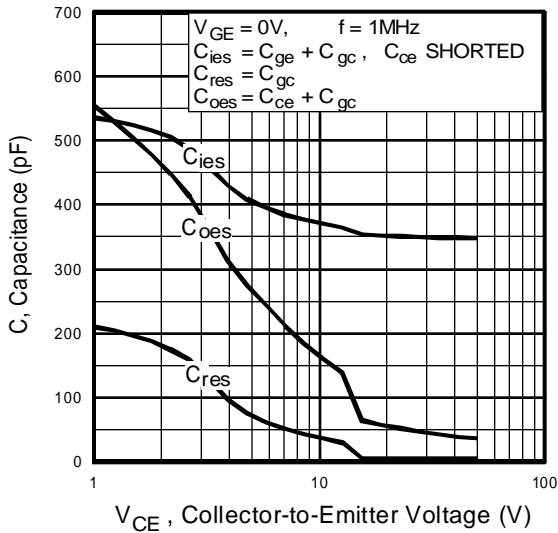

Fig. 7 - Typical Capacitance vs. Collector-to-Emitter Voltage

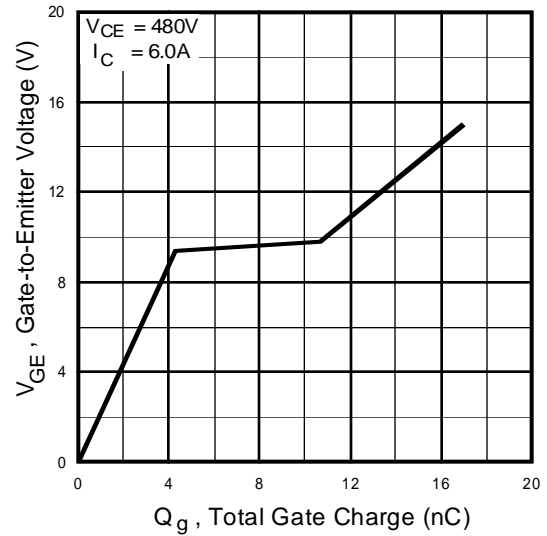

Fig. 8 - Typical Gate Charge vs. Gate-to-Emitter Voltage

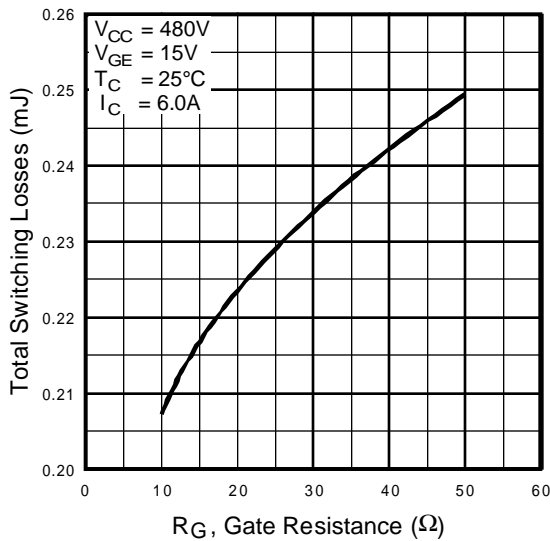

Fig. 9 - Typical Switching Losses vs. Gate Resistance

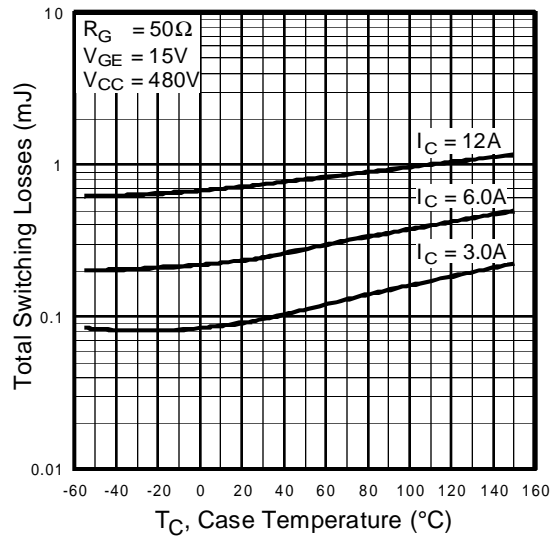

Fig. 10 - Typical Switching Losses vs. Case Temperature

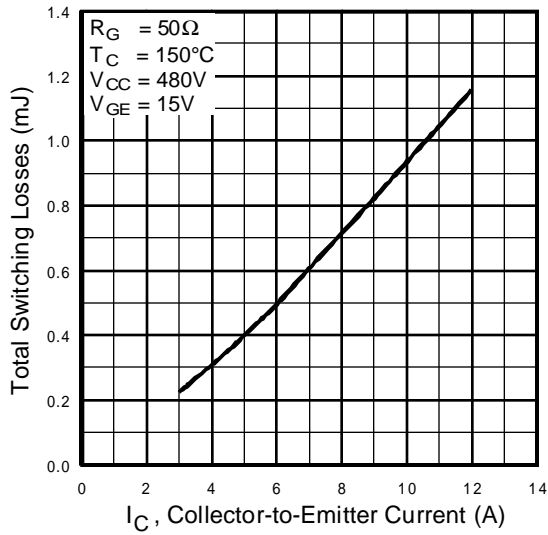

Fig. 11 - Typical Switching Losses vs. Collector-to-Emitter Current

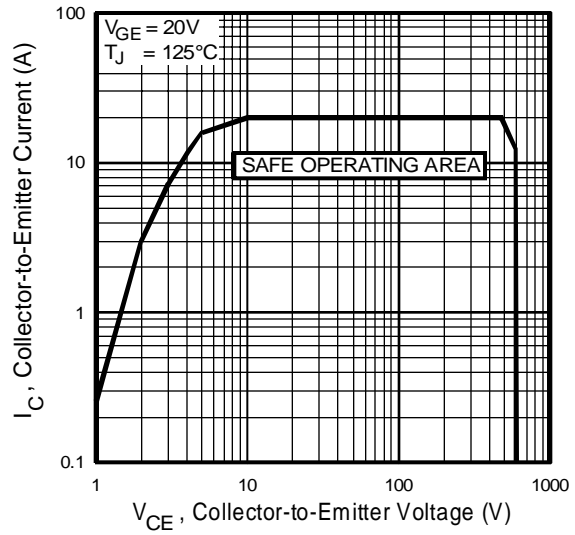
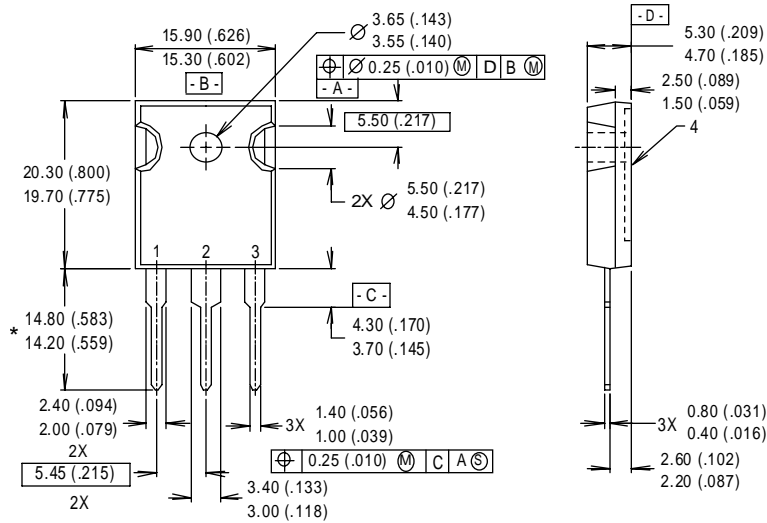

Fig. 12 - Turn-Off SOA



NOTES:
 1 DIMENSIONS & TOLERANCING PER ANSI Y14.5M, 1982.
 2 CONTROLLING DIMENSION : INCH.
 3 DIMENSIONS ARE SHOWN MILLIMETERS (INCHES).
 4 CONFORMS TO JEDEC OUTLINE TO-247AC.

LEAD ASSIGNMENTS
 1 - GATE
 2 - COLLECTOR
 3 - EMITTER
 4 - COLLECTOR

* LONGER LEADED (20mm) VERSION AVAILABLE (TO-247AD) TO ORDER ADD "-E" SUFFIX TO PART NUMBER

CONFORMS TO JEDEC OUTLINE TO-247AC (TO-3P)
 Dimensions in Millimeters and (Inches)

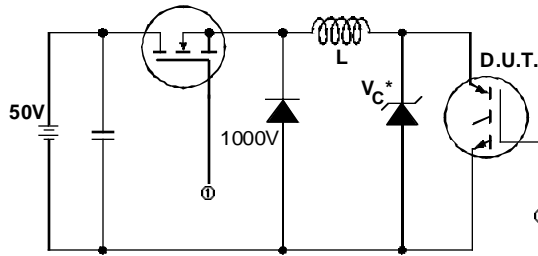

* Driver same type as D.U.T.; $V_c = 80\%$ of $V_{ce(max)}$
 * Note: Due to the 50V power supply, pulse width and inductor will increase to obtain rated I_d .

Fig. 13a - Clamped Inductive Load Test Circuit

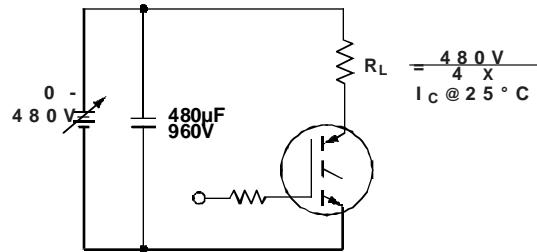

$$R_L = \frac{480V}{4} \times X$$

$I_C @ 25^\circ C$

Fig. 13b - Pulsed Collector Current Test Circuit

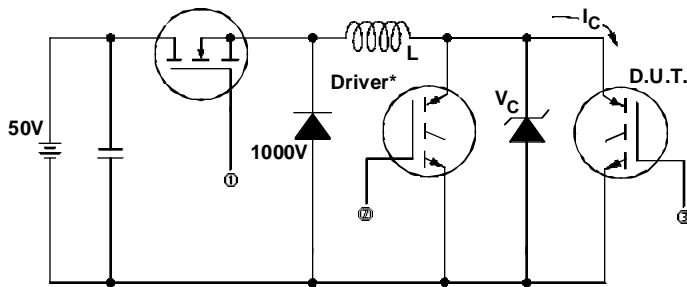

Fig. 14a - Switching Loss Test Circuit

* Driver same type as D.U.T., $V_C = 480V$

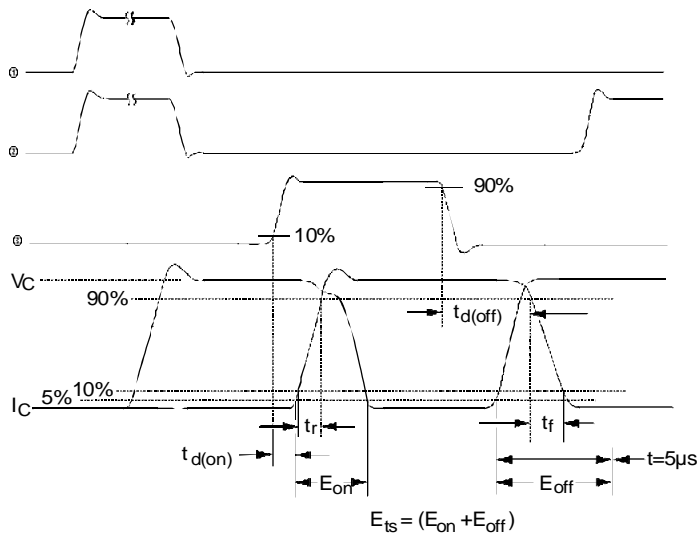

Fig. 14b - Switching Loss Waveforms